

Properties

- Ø18 mm housing
- 5 mm, flush mountable
- DC, 2-wire switching output
- Cable and connector versions

Technical Data

For detailed data and product description refer to the data sheets at www.pepperl-fuchs.com

General Data

Rated operating distance	5 mm
Installation	flush
Type of voltage	DC
Operating voltage	5 ... 60 V
Reverse polarity protection	tolerant
Operating current	2 ... 100 mA
Short-circuit protection	pulsing
Indication of the switching state	LED, yellow
Protection degree	IP67

Model Number

		green = preferred type					
Switching element function	DC NO	●	●	●	●	●	●
	DC NC			●			●
Switching frequency	0 ... 350 Hz		●	●		●	●
	0 ... 500 Hz	●			●		
Ambient temperature	-25 ... 70 °C (-13 ... 158 °F)	●	●	●	●	●	●
	-40 ... 70 °C (-40 ... 158 °F)			●			
Housing material	Stainless steel 1.4305 / AISI 303		●	●		●	●
	brass, nickel-plated	●			●		
Connection type	Device connector M12 x 1, 4-pin				●	●	●
	cable PUR, 2 m		●	●			
	cable PVC, 2 m	●					

Approvals and Certificates

UL approval	cULus Listed, General Purpose	●	●	●	●	●	●
CSA approval	cCSAus Listed, General Purpose	●	●	●	●	●	●
CCC approval	Certified by China Compulsory Certification (CCC)	●	●	●	●	●	●

Dimensions

Length L [mm]	40	55
Diameter D [mm]		18
Thread length l _t [mm]	37	40
Cap length l ₁ [mm]		0
Connector area l _c [mm]	0	15
LED position		Pos. C

Accessories This and more accessories can be found in chapter 10

See pages from 972 ... for cordsets See pages 1068 ... for mounting aids

- V1-G-BK** 4-pin, M12 female field-attachable connector
- V1-W-BK** 4-pin, M12 female field-attachable connector
- BF 18** Mounting flange, 18 mm
- EXG-18** Quick mounting bracket with dead stop
- V1-W-2M-PUR** Cable socket, M12, 4-pin, PUR cable
- V1-G-2M-PUR** Cable socket, M12, 4-pin, PUR cable

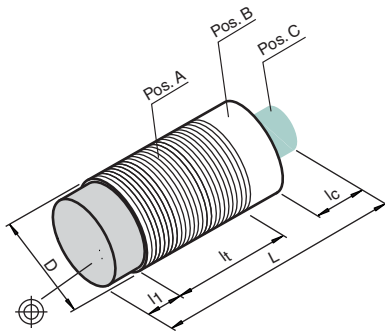

Electrical Connection

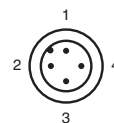
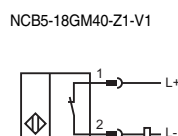
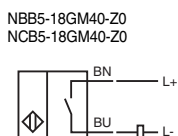
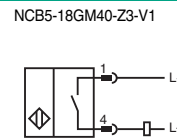
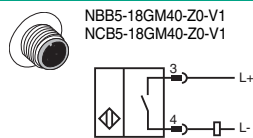
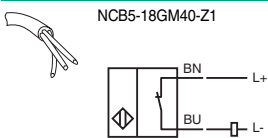

Wire colors in accordance with EN 60947-5-2

- 1 BN (brown)
- 2 WH (white)
- 3 BU (blue)
- 4 BK (black)